

Safe practice

*for the handling
of doctor blades*



JOH. CLOUTH®

Safety equipment

- When handling doctor blades always wear personal safety equipment.

We recommend:

**Cut-resistant gloves,
safety glasses,
safety shoes.**

Attention: Blade changes to made only when machine stopped!

System accessories

- Ensure appropriate tools are used when changing blades. We recommend:

CLOUTH DOCTOR-PULL®



CLOUTH-POWER-PULL®



- Dispose of used doctor blades as soon as possible.

An ideal solution is the

CLOUTH DOCTOR-CUT®



Attention: Never leave blades unattended in construction area, near gangways or on stairs!

Extreme high risk of injury!

- Optimal storage conditions are provided by the **CLOUTH DOCTOR-STORE**®.

When using the stores we supply the blade in the **CLOUTH DOCTOR-BOX**®.

The blades are equipped with system holes and connected to each other.

To remove the blades, it is not necessary for them to be unpacked.

The doctor blades are numbered in reverse, showing how many blades are left in each box.





Attention: When using other packaging, always take great care as the rolled blades are under high tension.

Adjusting recommendations and practical tips



JOH. CLOUTH[®]

Basic parameters for good doctoring

1. **Parallelism of doctor unit and roll/cylinder surface.**
2. **The correct angle.**
3. **The correct pressure.**
4. **The correct choice of doctor blade material.**
5. **Correct maintenance of the doctor holder system**
6. **Regular inspection of doctor bearings.**
(Eccentric adjustment, correct function of pneumatic cylinders and related components)

1. Parallelism of doctor unit and roll/cylinder surface.

When measuring the angle on the tender side and drive side the difference in angle should be under 2° .

For easy and fast measuring we recommend the **CLOUTH® BLADE ADJUSTING GAUGE**.

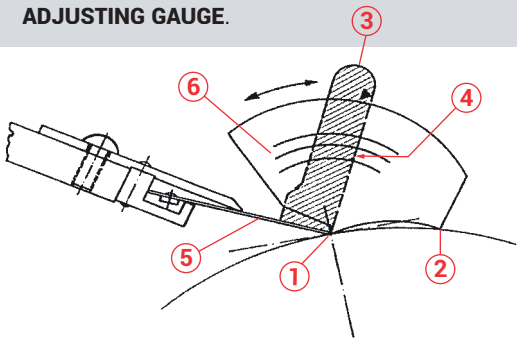

1. Clouth[®] Doctor Blade Adjusting Gauge with the point (1) at the Doctor blade tip and with point (2) on the roll surface.
2. Then, adjust the plastic slot (3) in such a way with lever (4) that this fits snugly on the blade, at measuring point (5). By means of scale (6) and the blue marked edge (4) at the slot you can read off current angle. The angle should be checked in this way at both tender and drive – sides of the machine and in between.
If all measurements are the same, the blade is adjusted equally across the roll face.



PLEASE NOTE

1. Always make measurements with a new doctor blade installed.
2. Please ensure that the blade pocket/holder groove is clean to ensure even blade contact.
3. Before changing the angle of a doctor blade, you are advised to check with your blade supplier.
4. Careful use of the Doctor Blade Adjusting Gauge is required to achieve accurate results.

2. The correct angle.

3. The correct pressure.

Changing of doctor blade loading during operation with run-in blade.

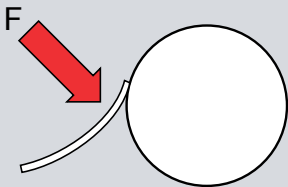

Attention: Never increase blade pressure during running as this may cause the accumulation of fibres under blade tip, leading to passing. Blade pressure may be reduced when running.

Roll surface	Blade angle	Blade pressure N/m
Hard chrome	25°-27°	100-150
Wolfram Carbide - coated	25°-27°	100-150
Polyurethane	15°-22°	50-100
Steel casting	25°-27°	100-150
NBR / SBR	15°-22°	50-100
Teflon coated	25°-27°	100-150
Ceramic coated	25°-27°	100-150

4. The correct choice of doctor blade material.

The correct choice of doctor blade material can be found in our main catalogue Joh. Clouth

Here are some examples of combinations which should **not** be used:

Chromed surface:

Copper rolls:

Teflon Coating:

Ceramic coating:

Chrome rolls:

We are pleased to offer you extensive training and advice.

No MONEL, STEEL, BRONZE, CLOUTH-MG-FF®,
DIACLOUTH-600®

No MONEL

No MONEL, BRONZE

No metal
except Clouth DT 1.4021 on CeraLease (Voith)

No special steel and no phenolic resin blades

5. Correct maintenance of the doctor holders.

- Regular cleaning of blade pocket and holder fingers.
- Ideal for this is the **CLOUTH DOCTOR - CLEAN®** System.

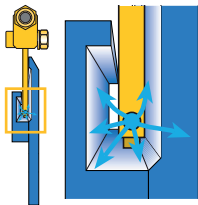
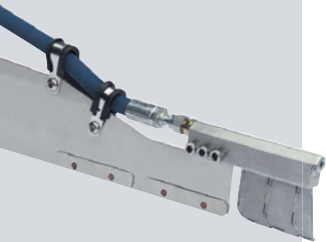

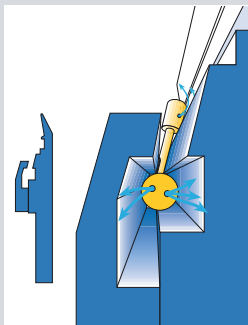

6. Regular inspection of doctor bearings.

When experiencing doctoring problems always check the doctor bearings and the mountings of the beam for parallelism and function (pneumatic cylinder).

Attention: Never adjust the doctoring system when the bearing is defective, as the forces created will change the geometry of the system.

**Adjustment mistakes
when mounting
doctor beams.**

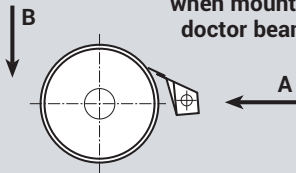

View A

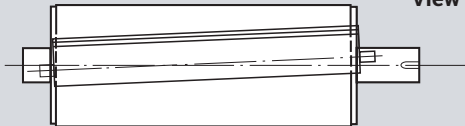

View B

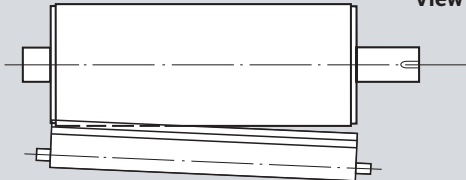



This advice is intended as a guide only and is given without prejudice. It is the responsibility of the user to ensure the suitability of products and conditions of use.

The use of our products is outside of our control and it is therefore the responsibility of each user to ensure suitability for each application.

Extensive help and
product descriptions
are available at:

www.clouth-eltmann.com

www.clouth.com

For further advice contact:

E-mail: info@clouth-eltmann.com

or

Telefon: +49 (0) 95 22 94 24 - 0

Joh. Clouth Maschinenbau Eltmann
GmbH & Co. KG
Industriestr. 25
D-97483 Eltmann



Notes

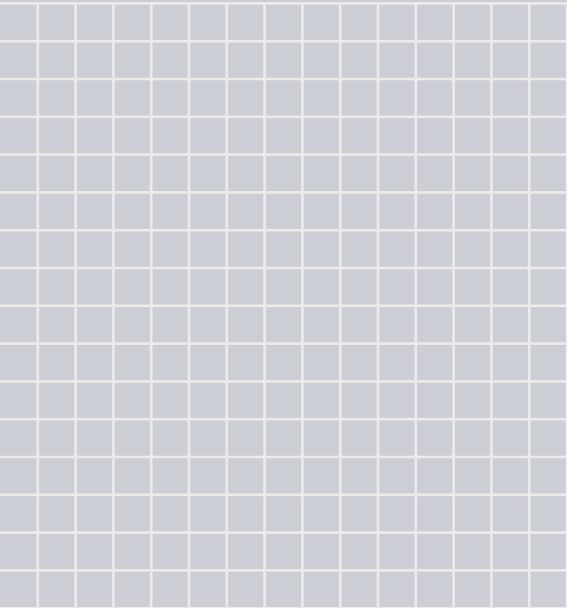



Notes

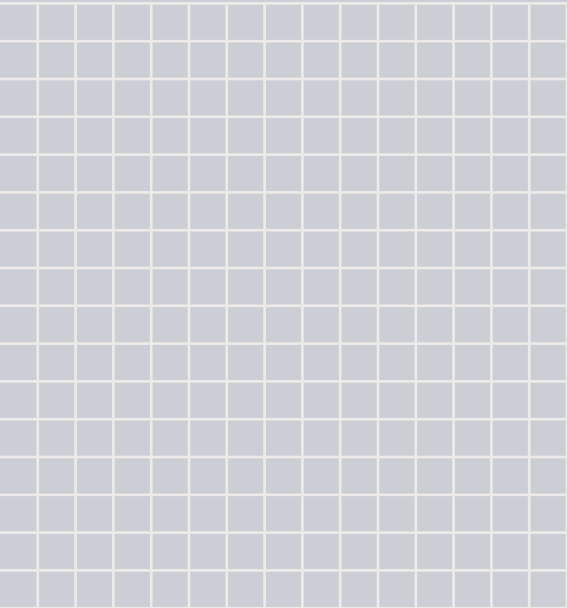



JOH. CLOUTH[®]